

CHAMBERLAIN®
merlin
 more than magic



MT230

The Classic Performer

With the power to open very large garage doors, this opener is a classic performer. Basic and functional design has been matched with modern electronics to produce this powerful AC opener. Engineered to open sectional and tilt garage doors up to 21m², the MT230 is a modern classic.

DOOR TYPES: for sectional and tilt garage doors up to 21m²

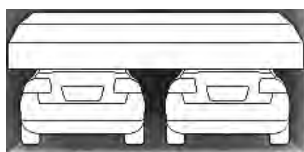

Double Sectional

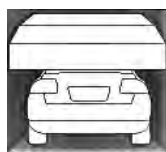

Single Sectional

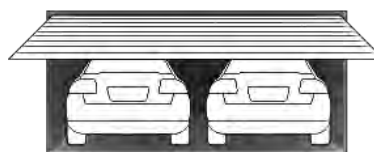

Double Tilt

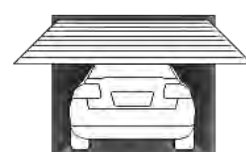

Single Tilt

KEY BENEFITS:

Drive System: *Chain*

Industrial strength chain drive system with one piece pole.

Accessories Included

This opener features two handheld mini transmitters and a wireless wall button. Illustrations are provided in the 'Kit Contents' section. See the reverse page for some optional accessories.

Dual Speed

The MT230 can be configured to run faster for sectional doors or slower for tilt doors. Compatible with older one-piece doors.

12V 100mA Accessory Output

Allows easy installation of wired accessory devices directly to the opener's power supply terminals.

Courtesy lighting

Extra compact 40 Watt light illuminates your garage when the opener is activated.

KIT CONTENTS:



1 x Powerhead



2 x Three channel key ring mini-transmitters C945



Wireless wall button CM128

Standard Merlin safety features

Automatic Safety Reverse

With its automatic safety function your garage door will stop and reverse automatically if obstructed going down or stop if obstructed going up. Your door can also be stopped and locked at any height for ventilation.

Automatic Force Sensing

Equipped with automatic force sensing, with each operation the garage door opener monitors and adjusts the force needed to open your garage door.

Manual Release

In case of power failure you can simply activate the manual release to open your garage door.

Warranty

The MT230 comes with a two year general warranty and a five year warranty on the motor. Unlimited operations for domestic use applications.

SPECIFICATIONS:

- 240V AC motor with thermal overload protection
- Input voltage: 240V AC
- Rated door area 21.0m²
- Pulling force: 700N
- One piece pole and chain drive system
- Dual speed sprocket: sectional door speed or tilt door speed. (Max travel 3.5m high gear, 2.6m low gear)
- 12V 100mA accessory output
- 433.92 MHz AM radio with Chamberlain Peak Detect™ rolling code technology
- Up to 64 memory registers
- Garage illumination - 240V/ Max 40Watt E27 (extra compact size)

Note: Use Philips Tornado 5W or similar size compact fluorescent globes



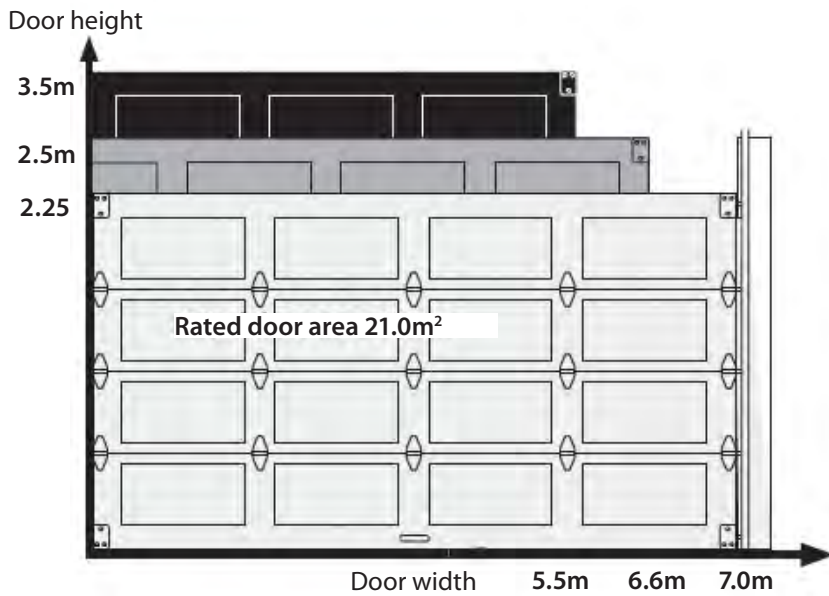

DOOR SPECIFICATIONS:

- Maximum lifting under spring tension—20 Kgs
- Suitable for steel and timber spring balanced doors
- Maximum lifting height (with extensions) 3.5m

DOOR OPENING AND CLOSING TIMES

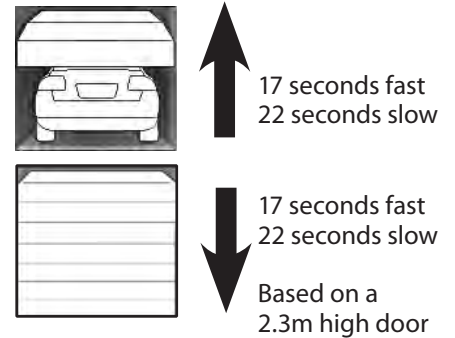

TYPICAL INSTALLATION - SECTIONAL DOOR

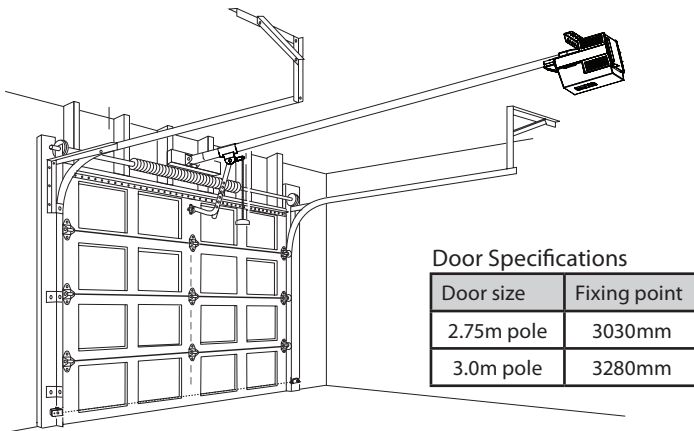

TYPICAL INSTALLATION - TILT DOOR

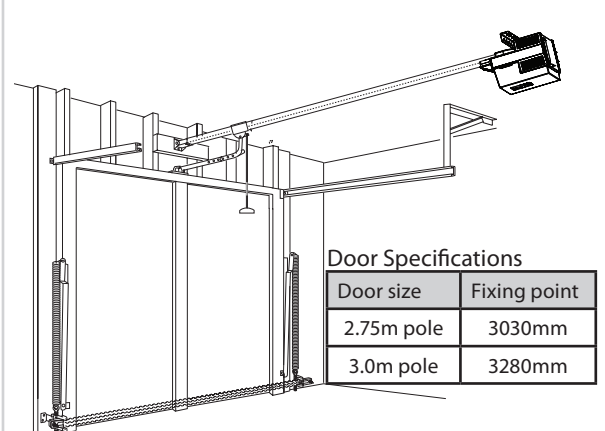

OPTIONAL ACCESSORIES



Motion detecting control panel. **C198**



Wall or visor mounted single channel transmitter. **C940**



4 channel mini-transmitter. **CM844**



Wireless open door monitor. **CLDM1ANZ**



Protector System safety beam sensors. **C77**



Fingerprint keyless entry pad. **C840**



Wireless Keypad. **C379**

...more than magic

Merlin is one of a group of brand names owned and managed by the Chamberlain Group, the world's largest manufacturer of garage door openers.

As a manufacturer of some of the world's most reliable and efficient products in our market, we are determined to build on our reputation as the industry leader by exceeding our customer's expectations, providing exceptional products and services.

Our preoccupation with quality not only applies to manufacturing. We insist on high performance standards in every aspect of our business, placing quality at the forefront of everything we do in the understanding that each of us is accountable for ensuring we achieve our quality objectives.

CHAMBERLAIN®

The Spirit of Automation

Chamberlain ANZ

Australia: T: 1800 638 234 F: 1800 888 121

New Zealand: T: 0800 653 667 F: 0800 653 663

E: sales@chamberlainanz.com

W: chamberlainanz.com

© 2010 The Chamberlain Group, Inc.

M0210S006

Specifications are subject to change without prior notice.

